

2023 MEDIA KIT



DIGITAL EDITION

PRINT DIRECTORY

Boaters Blue Pages
Annual Marine Directory
50,000
Copies distributed

PRINT MAGAZINE

Pacific Yachting
X12 Issues p/a
100,000
Readership

ONLINE

26,536
Website
Pageviews

SOCIAL

f **6,800+** followers
o **3,700+** followers
t **3,200+** followers

BRAND OVERVIEW



KEY FACTS

Founded in 1968
#1 Selling boating magazine on Canadian newsstands

12 issues a year

Glossy, perfect bound, high quality

100% owned, produced & printed in Canada

British Columbia and the U.S. Pacific Northwest offers boaters some of the most diverse, wild and scenic cruising grounds in the world, and nobody reaches more power and sail boaters in this region than *Pacific Yachting* magazine. Founded in 1968, *Pacific Yachting* is the voice of boating on the West Coast, and is the most trusted, best-selling and most well-read boating magazine in Canada. We have earned the trust of our readers and advertisers through decades of first class boating content, and have built on these partnerships through our support of local boating community events, boat shows and regattas.

Maximize your investment. From cruising destinations and vacation ideas to maintenance projects and product reviews, *Pacific Yachting* magazine provides trusted content to readers and advertisers through our print, digital, video and online formats.

In addition, our *Boaters Blue Pages and Marina Guide* print publication and its online counterpart, boatersbluepages.com, provide quick and easy access to marine-related businesses and marinas in our market. Advertise your business in the first place local boaters look for trusted information on boats and boating on the West Coast.

	PRINT	WEBSITE	SOCIAL
REACH	152,400 Readers	26,536 Pageviews	18,723 Followers
BREAKDOWN	100,00 Pacific Yachting 50,000 Boaters Blue Pages 2,400 Digital subscribers	26,536 Pageviews 16,810 Unique visitors 1:17 Time spent on site <small>*Sourced from 3 month averages in Google analytics</small>	3,700 Instagram followers 6,800 Facebook followers 3,200 Twitter followers 5,023 E-newsletter subscribers
MEDIAN AGE	45-65	-	25-34 / 35-44 Instagram / Facebook
DISTRIBUTION	73% BC 20% Washington State 7% Rest of Canada	-	58% BC 24% Washington State 4% UK
GENDER	64% Male / 36% Female	-	60% Male / 40% Female
MEDIAN HHI	\$75,000+	-	-



TOTAL BRAND REACH
197,659 BOATERS

READER PROFILE

59% own powerboats
41% own sailboats

59% of readers spend more than 30 days on the water every year

79% of readers have taken action on a product or business seen in *PY*

Primarily active boaters in B.C., Alberta, Washington, Oregon, and Alaska

DISPLAY RATES



SIZE

INSIDE
Double-Page Spread
Full Page
2/3 Page
1/2 Island
1/2 Horizontal
1/2 Vertical
1/3 Vertical
1/3 Square
Double 1/9
1/6 Vertical
1/9 Vertical

RATES

EFFECTIVE JANUARY 2023, GROSS RATES

1X	3X	6X	12X
\$6,360	\$5,600	\$4,860	\$4,250
\$3,775	\$3,650	\$3,500	\$3,200
\$3,370	\$3,240	\$3,120	\$2,860
\$3,210	\$3,090	\$2,970	\$2,730
\$2,900	\$2,800	\$2,590	\$2,485
\$2,900	\$2,800	\$2,590	\$2,485
\$2,310	\$2,235	\$2,160	\$2,010
\$2,310	\$2,235	\$2,160	\$2,010
\$1,895	\$1,810	\$1,740	\$1,650
\$1,685	\$1,645	\$1,595	\$1,505
\$1,440	\$1,405	\$1,375	\$1,315

DIMENSIONS

(WIDTH X HEIGHT)

SIZE	BLEED
16" X 10.75" Trim	16.25" X 11"
8" X 10.75" Trim	8.25" X 11"
4.5625" X 9.875"	n/a
4.5625" X 7.3125"	n/a
7" X 4.8125"	n/a
3.4" X 9.875"	n/a
2.25" X 9.875"	n/a
4.5625" X 4.8125"	n/a
4.5625" X 3.125"	n/a
2.25" X 4.8125"	n/a
2.25" X 3.125"	n/a

CUSTOM SPECIALS

Special Positions

Special or guaranteed position, **15% EXTRA.**

Inserts

Rates on request.

Videos

Video links to digital edition ads. Rates on request.

UPLOADING ADS

Email Ads to

blainew@pacificyachting.com

Bleed

Full page only 0.125".

Production Costs

Any production work on advertisements will be invoiced at **\$75 PER HOUR** to the advertiser.

File Formats

Press Optimized PDF

COVERS
Inside Front
Inside Back
Outside Back

1X	2X	3X	4X
\$4,360	\$4,135	\$3,915	\$3,480
\$4,245	\$4,035	\$3,915	\$3,480
\$4,620	\$4,390	\$4,155	\$3,695

TRIM	BLEED
8" X 10.75"	8.25" X 11"
8" X 10.75"	8.25" X 11"
8" X 10.75"	8.25" X 11"

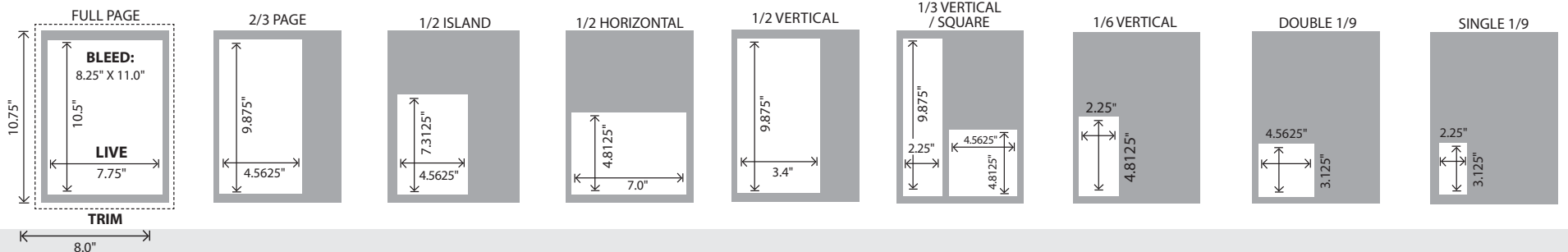

RETAIL RATES



SIZE

INSIDE
Full Page
2/3 Page
1/2 Island
1/2 Horizontal
1/3 Vertical
1/3 Square
Double 1/9
1/6 Vertical
1/9 Vertical

RATES

EFFECTIVE JANUARY 2023, GROSS RATES

	1X	3X	6X	12X
Full Page	\$2,625	\$2,405	\$2,190	\$1,970
2/3 Page	\$2,320	\$2,135	\$1,945	\$1,760
1/2 Island	\$2,020	\$1,845	\$1,675	\$1,500
1/2 Horizontal	\$1,800	\$1,645	\$1,500	\$1,344
1/3 Vertical	\$1,365	\$1,260	\$1,150	\$1,045
1/3 Square	\$1,365	\$1,260	\$1,150	\$1,045
Double 1/9	\$ 985	\$ 905	\$ 830	\$ 745
1/6 Vertical	\$ 830	\$ 765	\$ 705	\$ 640
1/9 Vertical	\$ 650	\$ 610	\$ 565	\$ 520

DIMENSIONS

(WIDTH X HEIGHT)

SIZE	BLEED
8" X 10.75" Trim	8.25" X 11"
4.5625" X 9.875"	n/a
4.5625" X 7.3125"	n/a
7" X 4.8125"	n/a
2.25" X 9.875"	n/a
4.5625" X 4.8125"	n/a
4.5625" X 3.125"	n/a
2.25" X 4.8125"	n/a
2.25" X 3.125"	n/a

CUSTOM SPECIALS

Special Positions

Special or guaranteed position, **15% EXTRA.**

Inserts

Rates on request.

Videos

Video links to digital edition ads. Rates on request.

UPLOADING ADS

Email Ads to

blainew@pacificyachting.com

Bleed

Full page only 0.125".

Production Costs

Any production work on advertisements will be invoiced at **\$75 PER HOUR** to the advertiser.

File Formats

Press Optimized PDF

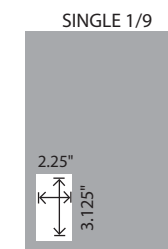
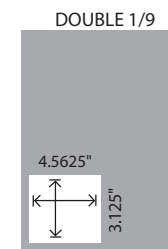
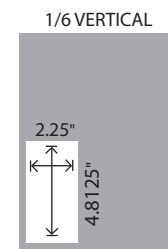
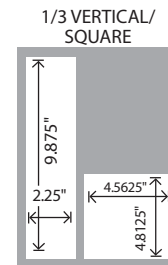
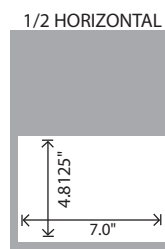
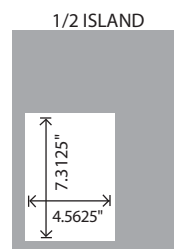
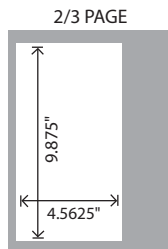
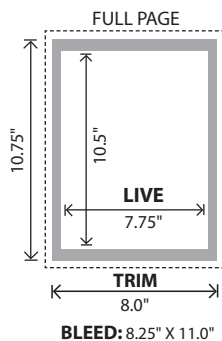

BROKER RATES



The brokerage section is for the sale of used boats and is limited to advertisements from dealers and brokers. Dealers are allowed up to 20% of their brokerage ad for new boat information (product name, photos and logo) at no additional cost. The retail rate will apply to the portion of new boat advertising exceeding the 20% limit. Production service charges apply. No agency commission.

SIZE	RATES				DIMENSIONS	
INSIDE	EFFECTIVE JANUARY 2023, GROSS RATES				(WIDTH X HEIGHT)	
Full Page	1X	3X	6X	12X	TRIM	BLEED
	\$1,385	\$1,250	\$1,065	\$855	8" X 10.75" Trim	8.25" X 11"

CUSTOM SPECIALS

Special Positions
Special or guaranteed position,
15% EXTRA.

Inserts
Rates on request.

Videos
Video links to digital edition ads.
Rates on request.

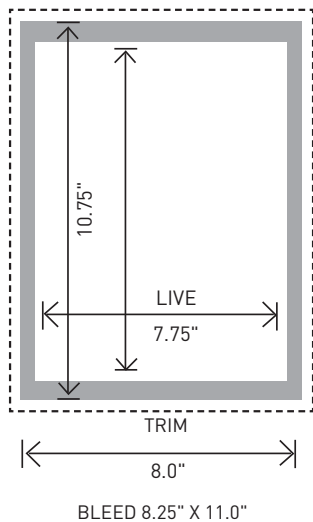

UPLOADING ADS

Email Ads to
blainew@pacificyachting.com

Bleed
Full page only 0.125".

Production Costs
Any production work on advertisements will be invoiced at **\$75 PER HOUR** to the advertiser.

File Formats
Press Optimized PDF

CHARTER RATES



SIZE	RATES				DIMENSIONS	
	EFFECTIVE JANUARY 2023, GROSS RATES				(WIDTH X HEIGHT)	
INSIDE	1X	3X	6X	12X	SIZE	BLEED
Full Page	\$1,870	\$1,695	\$1,470	\$1,325	8" X 10.75" Trim	8.25" X 11"
1/2 Horizontal	\$1,375	\$1,240	\$1,090	\$985	7" X 4.8125"	n/a
1/4 Vertical	\$825	\$750	\$675	\$615	3.325" X 4.8125"	n/a

CUSTOM SPECIALS

Special Positions

Special or guaranteed position, **15% EXTRA.**

Inserts

Rates on request.

Videos

Video links to digital edition ads. Rates on request.

UPLOADING ADS

Email Ads to

blainew@pacificyachting.com

Bleed

Full page only 0.125".

Production Costs

Any production work on advertisements will be invoiced at **\$75 PER HOUR** to the advertiser.

File Formats

Press Optimized PDF

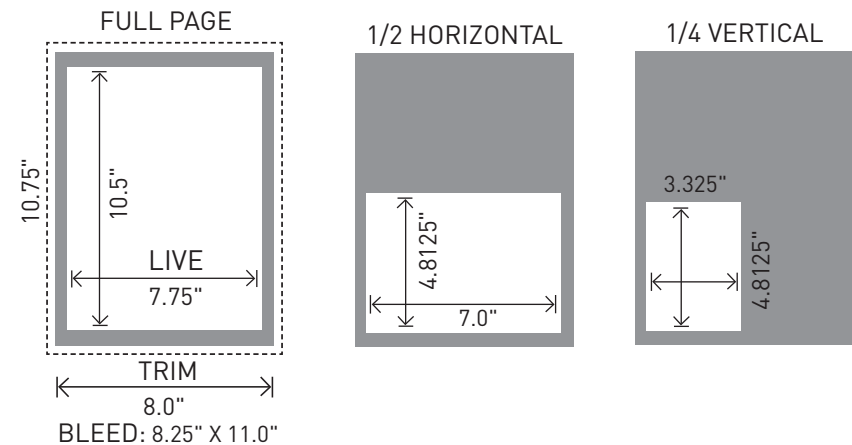

CLASSIFIED RATES



Display ads in the classifieds are reasonably priced and have set sizes. They can include colour borders, background colours, photo backgrounds, superimposed text, logos, inserted photos, etc. See below for pricing and sizes.

EFFECTIVE JANUARY 2023, GROSS RATES

LINERS

\$1.50 a word with a \$25.00 minimum.

\$50.00 per full colour 1.6" X 1" photo. Frequency discounts available. Liner ads are a great way to advertise for extended periods.

CUSTOM SPECIALS

Special Positions

Special or guaranteed position, **15% EXTRA.**

Inserts

Rates on request.

Videos

Video links to digital edition ads. Rates on request.

UPLOADING ADS

Email Ads to

gfidler@opmediagroup.ca

Bleed

Full page only 0.125".

Production Costs

Any production work on advertisements will be invoiced at **\$75 PER HOUR** to the advertiser.

File Formats

Press Optimized PDF

<p>FULL PAGE</p> <p>\$1,660</p> <p>A</p> <p>7" x 9 5/8"</p>	<p>3/4 PAGE VERTICAL</p> <p>\$1,245</p> <p>B</p> <p>5 3/16" x 9 5/8"</p>	<p>1/2 PAGE HORIZONTAL</p> <p>\$830</p> <p>C</p> <p>7" x 4 3/4"</p>	<p>1/2 PAGE VERTICAL</p> <p>\$830</p> <p>D</p> <p>3 3/8" x 9 5/8"</p>
<p>3/8 PAGE HORIZONTAL</p> <p>\$625</p> <p>E</p> <p>5 3/16" x 4 3/4"</p>	<p>1/4 PAGE VERTICAL</p> <p>\$455</p> <p>F</p> <p>3 3/8" x 4 3/4"</p>	<p>1 FULL COLUMN</p> <p>\$455</p> <p>G</p> <p>1 9/16" x 9 5/8"</p>	<p>1 COLUMN X 6" VERTICAL</p> <p>\$365</p> <p>H</p> <p>1 9/16" x 6"</p>
<p>2 COLUMN X 3" HORIZONTAL</p> <p>\$365</p> <p>I</p> <p>3 3/8" x 3"</p>	<p>1 COLUMN X 5" VERTICAL</p> <p>\$324</p> <p>J</p> <p>1 9/16" x 5"</p>	<p>1 COLUMN X 4" VERTICAL</p> <p>\$275</p> <p>K</p> <p>1 9/16" x 4"</p>	<p>2 COLUMN X 2" HORIZONTAL</p> <p>\$275</p> <p>L</p> <p>3 3/8" x 2"</p>
<p>1 COLUMN X 3" VERTICAL</p> <p>\$222</p> <p>M</p> <p>1 9/16" x 3"</p>	<p>2 COLUMN X 1" HORIZONTAL</p> <p>\$156</p> <p>N</p> <p>3 3/8" x 1"</p>	<p>1 COLUMN X 2" VERTICAL</p> <p>\$156</p> <p>O</p> <p>1 9/16" x 2"</p>	<p>CAPTAIN'S CHAIR</p> <p>\$200</p> <p>P</p> <p>2" x 2 1/2"</p>

REAL ESTATE RATES



Display ads in real estate are reasonably priced and have set sizes. They can include colour borders, background colours, photo backgrounds, superimposed text, logos, inserted photos, etc. See below for pricing and sizes.

SIZE		RATES	DIMENSIONS
#	INSIDE	GROSS RATES	(WIDTH X HEIGHT)
A	Full Page	\$1660	7" X 9.625"
B	1/2 Vertical	\$830	3.375" X 9.65"
C	1/2 Horizontal	\$830	7" X 4.75"
D	1/4 Vertical	\$455	3.4" X 4.75"
E	2 Column x2	\$275	3.38" X 2.25"

UPLOADING ADS

Email Ads to
blainew@pacificyachting.com

Bleed
Full page only 0.125".

Production Costs
Any production work on advertisements will be invoiced at **\$75 PER HOUR** to the advertiser.

File Formats
Press Optimized PDF

CUSTOM SPECIALS

Special Positions
Special or guaranteed position, **15% EXTRA.**

Inserts
Rates on request.

Videos
Video links to digital edition ads. Rates on request.



1/2 VERTICAL AD EXAMPLE

1/4 VERTICAL AD EXAMPLE

FULL PAGE AD EXAMPLE

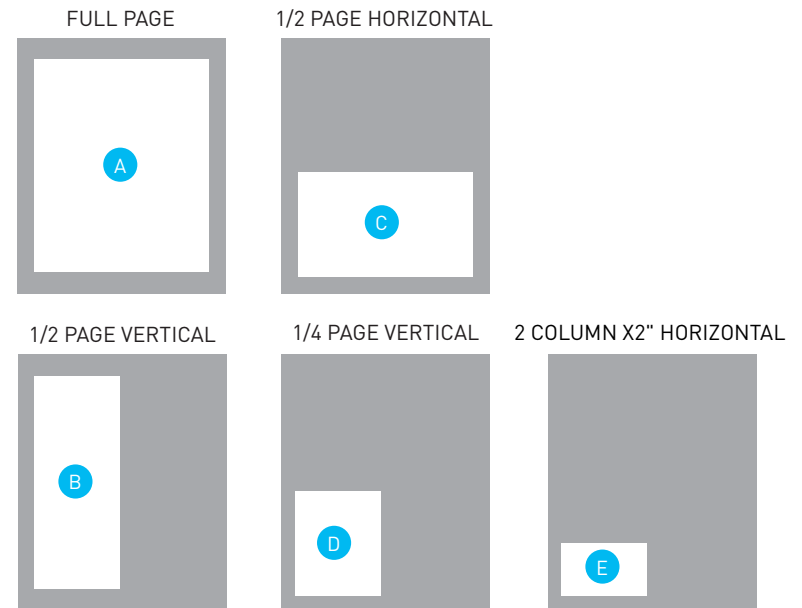

DIGITAL & SOCIAL MEDIA



PACIFICYACHTING.COM

Pacificyachting.com is the perfect online partner to our magazine. Where our print and digital publication delivers in depth articles and information for boaters in British Columbia and the Pacific Northwest, our interactive website offers our community the opportunity to connect more frequently. As well, the *Boaters Blue Pages & Marina Guide* is available online as a searchable directory with over 1,800 marine services and much more.

FEATURES & HIGHLIGHTS

- Blog, news, photos, videos, articles and more
- Banner advertising opportunities
- Classifieds
- E-Newsletter
- Events calendar
- Direct link to boatersbluepages.com
- Direct link to digital magazine
- Contests and polls
- Social media updates

WEB RATES & DIMENSIONS

Leaderboard	728 X 90	\$20 (CPM)
Big Box	300 X 250	\$20 (CPM)
Small Banner	468 X 60	\$20 (CPM)
Homepage Wallpaper	160 X 600	\$25 (CPM)

E-Newsletter:

Leaderboard	728 X 90	\$250
Big Box	300 X 250	\$250

Other:

Section sponsorship:	\$28 (CPM)
Homepage takeover:	\$1000 (CPD)
Social Media Mentions:	\$100 per mention

PACKAGES

EFFECTIVE JANUARY 2023, GROSS RATES

	A PACKAGE	B PACKAGE	C PACKAGE	D PACKAGE
Online Ad Impressions	25,000	50,000	125,000	250,000
E-Newsletter	2	3	4	6
Product/Destination Review	-	-	1	2
Social Media Mention	2	3	4	6
Value	\$500	\$1,250	\$4,200	\$8,800
Net Price	\$500	\$1,000	\$2,500	\$5,000
Discount	0%	20%	40%	43%

HOME PAGE

970 X 250
970 X 90
728 X 90
468 X 60
320 X 50
300 X 250

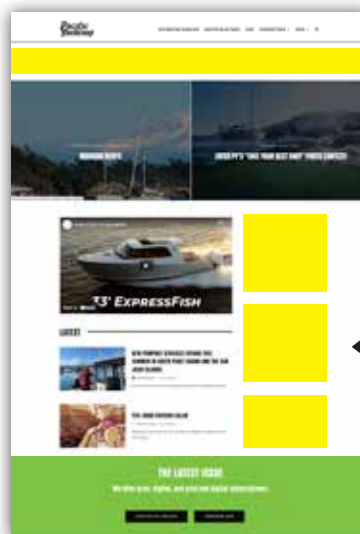

300 X 250

ARTICLE PAGE

970 X 250
970 X 90
728 X 90
468 X 60
320 X 50
300 X 250



300 X 250

EDITORIAL CALENDAR & DEADLINES

 = Power Squadrons issue

JANUARY ISSUE

Key feature: 2023 Season Preview

- Marina and cruising area updates
- New apps and services
- Winter cruising ideas and off-season adventure

Reservation Deadline **18 Nov**

Camera Ready Deadline **24 Nov**

Newsstand Date **19 Dec**



MAY ISSUE

Key feature: Eco Boating Special / Safe Boating Month

- Eco-friendly products and tips
- Environmental issues
- Safe boating tips and equipment

Reservation deadline **31 Mar**

Camera Ready Deadline **6 April**

Newsstand Date **1 May**



SEPTEMBER ISSUE

Key feature: Autumn Cruising

- Extending the cruising season: short trips, new ideas
- New product buying guide

Reservation deadline **21 July**

Camera Ready Deadline **27 July**

Newsstand Date **21 Aug**

FEBRUARY ISSUE

Key feature: Boat Show / New Boats

- New power and sailboats for 2023
- Winter cruising ideas and destinations
- Photo contest

Reservation Deadline **12 Dec**

Camera Ready Deadline **19 Dec**

Newsstand Date **23 Jan**

JUNE ISSUE

Key feature: Small Boat Special

- Small boats, both power and sail: trailering, lake boats, commuter boats, runabouts, aluminum
- New small boat roundup
- New product buying guide

Reservation Deadline **28 April**

Camera Ready Deadline **4 May**

Newsstand Date **29 May**



OCTOBER ISSUE

Key feature: Fall Maintenance

- Fall cruising fun
- Decommissioning tips
- Ideas for winter projects

Reservation Deadline **25 Aug**

Camera Ready Deadline **31 Aug**

Newsstand Date **25 Sept**

MARCH ISSUE

Key feature: Spring Commissioning

- Spring tips, including maintenance, cleaning, repairs, provisioning
- Marine Power. What's new in marine engines

Reservation Deadline **27 Jan**

Camera Ready Deadline **2 Feb**

Newsstand Date **27 Feb**

JULY ISSUE

Key feature: Summer Cruising

- Roundups, gunkholes, destinations, cruising ideas.
- Fun projects, historical pieces

Reservation Deadline **26 May**

Camera Ready Deadline **1 June**

Newsstand Date **26 June**

NOVEMBER ISSUE

Key feature: Chartering the World

- World-wide chartering hot spots, chartering stories and tips
- Winter cruising stories and ideas
- DIY winter projects

Reservation Deadline **23 Sept**

Camera Ready Deadline **28 Sept**

Newsstand Date **23 Oct**

APRIL ISSUE

Key feature: Marine Electronics Special

- What's new in marine electronics, including nav equipment, GPS/chartplotters, radar, sonar & more

Reservation Deadline **24 Feb**

Camera Ready Deadline **2 March**

Newsstand Date **27 Mar**



AUGUST ISSUE

Key feature: Summer Cruising / Classic Boats

- Gunkholes, destinations, cruising ideas
- Classic boat profiles and buying guides
- Maintenance and restorations

Reservation Deadline **23 June**

Camera Ready Deadline **29 June**

Newsstand Date **24 July**



DECEMBER ISSUE

Key feature: Holiday Gift Guide

- Winter cruising stories and ideas
- Rendezvous Roundup
- Holiday Gift Guide

Reservation Deadline **20 Oct**

Camera Ready Deadline **26 Oct**

Newsstand Date **20 Nov**



2023 Media Kit

BRITISH COLUMBIA

MAGAZINE

#1
HIGHEST
SINGLE ISSUE
SELLING
MAGAZINE
IN BC



DIGITAL EDITION

Online archives



PRINT DIRECTORY

Road Trips Special Issue
X1 Issue p/a
50,000
Readership



PRINT MAGAZINE

British Columbia Magazine
X4 Issues p/a
300,000
Readership



ONLINE

135,365
Website
Pageviews



SOCIAL

f **48K +** followers
@ **95K +** followers
t **15K +** followers

Brand Overview

	PRINT	WEBSITE	SOCIAL
REACH	350,000 Readers	135,365 Pageviews	169,257 Followers
BREAKDOWN	300,000 British Columbia Magazine (50,000 international) 50,000 Road Trip Guide	97,080 Unique visitors 0:39 Time spent on site <i>*Sourced from 3 month averages in Google analytics</i>	95,500 Instagram followers 48,185 Facebook followers 15,700 Twitter followers 9,872 E-newsletter subscribers
MEDIAN AGE	35-64	-	25-34 / 35-44 Instagram / Facebook
DISTRIBUTION	59% BC 23% International 18% Rest of Canada	-	89% Canada 7% USA 4% UK
GENDER	53% Male / 47% Female	-	44% Male / 56% Female
MEDIAN HHI	\$75,000+	-	-

TOTAL BRAND REACH
654,622

BRITISH COLUMBIA MAGAZINE
5,057
copies per issue

House and Home
4,644
copies per issue

MacLean's
1,260
copies per issue

Van Mag
612
copies per issue

British Columbia Magazine is the
HIGHEST
single issue selling magazine in BC

Founded in 1959

Strongest Media Buy in British Columbia

4 Issues per year

100% owned & produced in British Columbia

British Columbia Magazine is the scenic geographic and travel magazine of British Columbia, read worldwide for its big-picture photography and trusted travel journalism. Our quarterly issues profile: travel, outdoor exploration, adventure and recreation; parks, wilderness, wildlife, geography and conservation; history and heritage places in the province; science and natural phenomena; remarkable people and First Nations culture.

For more than 60 years *British Columbia Magazine* (launched as *Beautiful British Columbia*) has informed, entertained, surprised and inspired its readers with all that B.C. has to offer. We are a conduit for readers who want to know B.C. better, embrace living here and plan their travels to yet-to-be-explored places around the province.

Website

EFFECTIVE JANUARY 2023, GROSS RATES

BRITISH
COLUMBIA
MAGAZINE

135,365
MONTHLY
PAGEVIEW

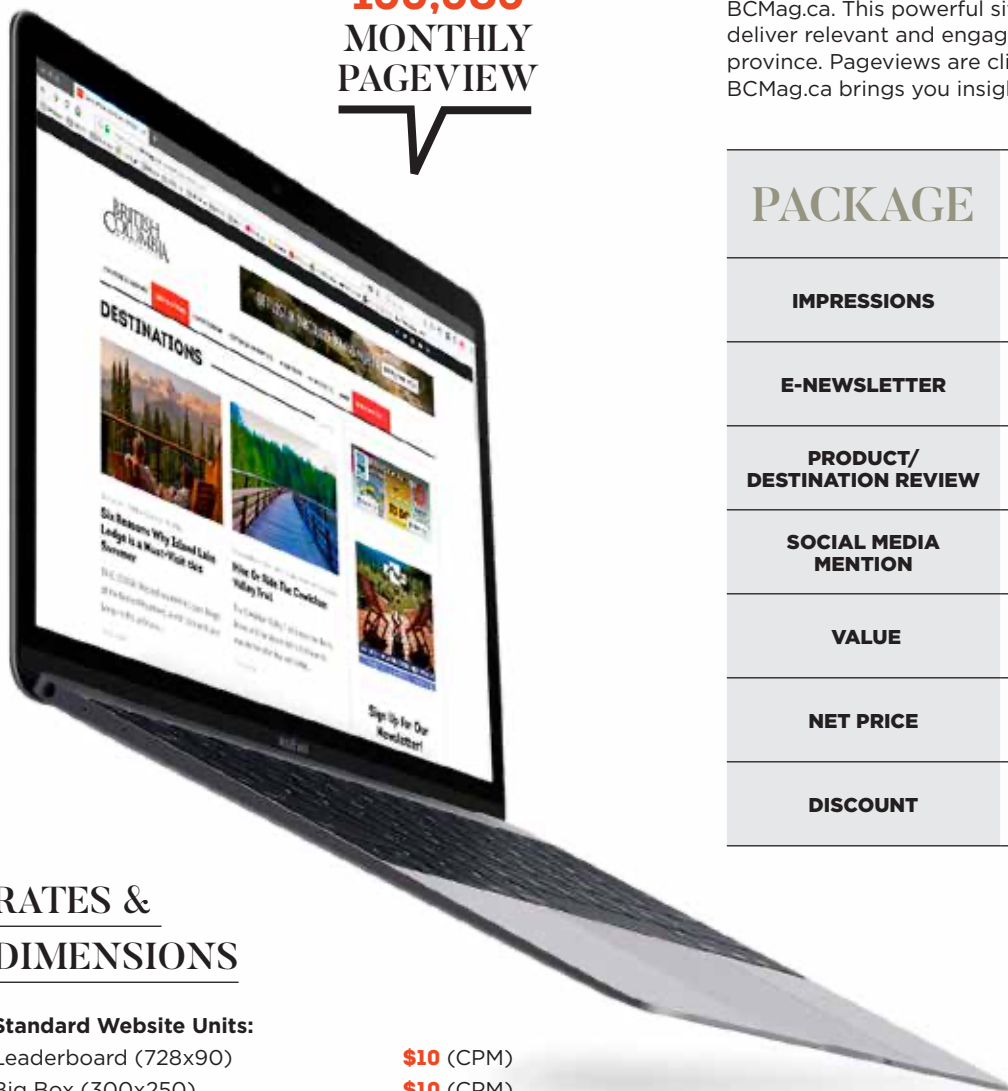

BCMAG.CA

British Columbia Magazine's 700,000+ readers are beginning to notice BCMag.ca. This powerful site has just gone through a transformation to deliver relevant and engaging content for all those interested in our great province. Pageviews are climbing daily and interaction time has doubled. BCMag.ca brings you insightful stories, beautiful imagery and timely lists.

PACKAGE	A	B	C	D
IMPRESSIONS	50,000	75,000	125,000	250,000
E-NEWSLETTER	1	2	4	6
PRODUCT/ DESTINATION REVIEW	-	-	1	2
SOCIAL MEDIA MENTION	2	3	4	6
VALUE	\$500	\$1,250	\$4,200	\$8,800
NET PRICE	\$500	\$1,000	\$2,500	\$5,000
DISCOUNT	0%	20%	40%	43%

RATES & DIMENSIONS

Standard Website Units:

Leaderboard (728x90)	\$10 (CPM)
Big Box (300x250)	\$10 (CPM)
Small Banner (468x60)	\$10 (CPM)
Homepage Wallpaper (160x600)	\$10 (CPM)

CONTESTS

Based on a 6-week promotion includes:
contest creation, 1 contest ad, contest page
write up, list of entry names and social media
mentions for duration of contest **\$2500**.
ROS promotion: **\$20** (CPM)

Social

EFFECTIVE JANUARY 2023, GROSS RATES



BRITISH COLUMBIA MAGAZINE

95,500+
followers

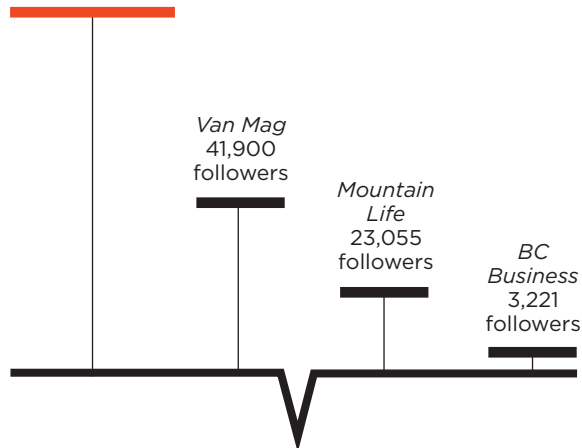

British Columbia Magazine has the
3RD LARGEST
Canadian magazine Instagram account

#BRITISHCOLUMBIAMAGAZINE

Boost awareness, promote your brand and build engagement with BC Mag social campaigns. Find out what we can do for you.

95,500+
followers



48,185+
followers



15,700+
followers



SINGLE

Tagging or mention **\$200**

Dedicated post **\$125**

Giveaway / Competitions **\$350**

Story **\$300**

CAMPAIGN PACKAGES

X2 Posts
X2 Stories **\$350**

X2 Posts
X4 Stories **\$500**

X4 Posts
X6 Stories **\$750**

Other Packages available on request.



TOTAL SOCIAL REACH
169,257*

**Includes 9,872 E-newsletter subscribers*

Online Advertorial

EFFECTIVE JANUARY 2023, GROSS RATES

Share your knowledge and expertise with specialized content featuring your brand.
Learn more about our storytelling opportunities.

Sponsored
Content
example

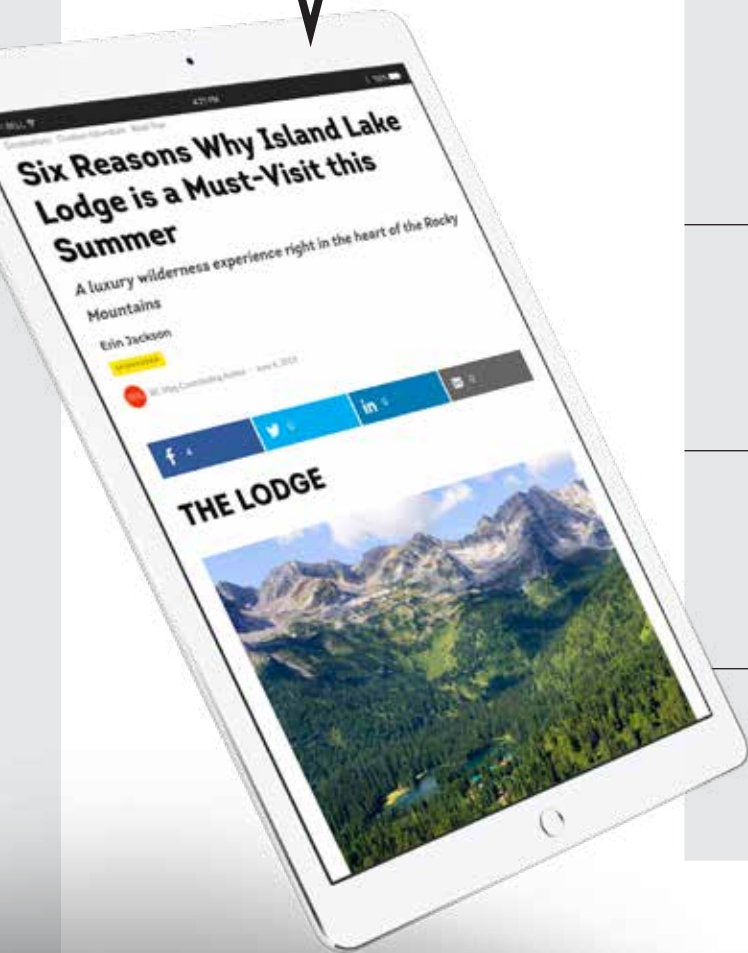

CONTENT	DESCRIPTION	PRICE
LISTICLES	<p>Compelling content presented in the form of a list. Features big subheads and often numbered for an easy to read format, for example "8 of the best ski hills in BC". Topics may include: advice, products, round-ups etc.</p> <p>Pro: Easy and fast to read, informative, quick to produce, good for traffic building</p>	\$750
LONG-FORM ARTICLES	<p>Journalistic in nature, these pieces are value based, sophisticated content that provides important and original information. Often includes an interview with an expert voice.</p> <p>Pro: Long-form, quality, detailed information and are really good for building integrity of the brand.</p>	\$2500
Q&A	<p>Interview with an expert voice. Provides practical and specialized info that gives a human voice behind a brand, issue or theme.</p> <p>Pro: Good piece for companies that have interesting story/people that can share information or knowledge on a subject.</p>	\$1000
PHOTO GALLERIES	<p>Share a story with beautiful visuals that represent your brand. A series of images with compelling captions.</p> <p>Pro: Catches readers eye, strong visuals are a great way to promote instagrammable opportunities.</p>	\$750 (if photos are supplied)

Destination Packages

Be *British Columbia Magazine's* feature destination! These strategic packages provide a unique storytelling opportunity. With four print issues a year, there is limited availability, and that puts your organization at a competitive advantage. Combined with our thriving online space, and high quality content, this is a chance to attract thousands of readers to your destination.

SINGLE PROMOTION

1500 word feature, print & online

1 Full page ad

2 Social media mentions

\$10,000

CAMPAIGN PACKAGE LIGHT

1500 word feature, print & online

X2 Full page ads

Website banner ad (100,000 impressions)

4 Social media mentions

2 Newsletter ads

\$15,000

CAMPAIGN PACKAGE

2500 word feature, print & online

X4 Full page ads

Website banner ad (250,000 impressions)

6 Social media mentions

6 Newsletter ads

\$21,000

kamloops
BOLDLY UNSCRIPTED

Sponsored Content example
Summer 2019 issue



Other Packages available on request.



Consumer Bundles

All bundles are customisable and flexible to suit your advertising needs. Other bundles available on request.

EFFECTIVE JANUARY 2023, GROSS RATES

BUNDLE	DESCRIPTION	PRINT		ONLINE				
		AD SIZE	FEATURE	BC MAG ONLINE CONTENT	AD IMPRESSIONS	E-NEWS-LETTERS	SOCIAL MEDIA PUSH	PRICE
SOCIAL BUTTERFLY	Integrated campaign to build social media exposure and reader confidence. This campaign bundle is designed to increase your social presence and begin the conversation. Strong support through call-to-action online and print placements round off this campaign.	X4 Half Page in BC Magazine	-	4 Pieces of Online Content Plus 1 Premium Pillar Online Article	500,000	-	4	\$9,800
TRAFFIC BUILDER	Integrated campaign to drive traffic to your website through this strategic bundle. This campaign is designed to leverage online articles with strategic call to action online and display ad placements.	X2 Full Page in BC Magazine X1 Full Page in Road Trips Guide	-	4 Pieces of Content OR 1 Pillar + 1 Piece of Content	1,000,000	12	5	\$12,270
EDUCATIONAL EXPERIENCE	Integrated campaign that does a deep dive into the special value proposition. This campaign is focused on storytelling and print, with a healthy balance of online to pull it together.	X2 Outside Cover in BC Magazine X2 Full Page in BC Magazine X1 Full Page in Road Trips Guide	1 Print Feature in BC Magazine	3 Pieces of Highlight Online Content AND 1 Feature Online Content	750,000	4	8	\$17,275
MINI BUNDLE	Templated bundles for smaller partners or those wishing to try integration.	X2 Half Page in BC Magazine	-	1 Feature Online	100,000	2	2	\$6,472

Display Rates & Dimensions

EFFECTIVE JANUARY 2023, GROSS RATES

NATIONAL DISPLAY RATES

SIZE	1X	2X	3X	4X
Full Page	\$4,900	\$4,605	\$4,015	\$2,500
2/3 Page	\$3,420	\$3,095	\$2,585	\$1,500
1/2 Page	\$2,450	\$2,260	\$1,880	\$1,300
1/3 Page	\$2,050	\$1,918	\$1,654	\$1,250
1/6 Page	\$1,201	\$1,116	\$946	\$650
DPS	\$7,424	\$6,810	\$5,612	\$3,000
1/2 DPS	\$3,712	\$3,405	\$2,800	\$2,500

COVERS	1X	2X	3X	4X
IFC Spread	\$6,360	\$5,707	\$5,054	\$4,401
IFC	\$5,870	\$5,535	\$4,715	\$4,025
IBC	\$5,500	\$5,107	\$4,305	\$3,782
OBC	\$5,880	\$5,535	\$4,715	\$4,025

DISPLAY AD DIMENSIONS (WIDTH X HEIGHT)

SIZE	NON BLEED	TRIM SIZE FOR BLEED ADS
Double-Page Spread	15.5" X 10.25"	16" x 10.75"
Full Page Live	7.75" X 10.5"	8" x 10.75"
2/3 Page	4.5625" X 9.875"	n/a
1/2 Page Vertical	3.5" X 9.875"	n/a
1/2 Page Horizontal	7" X 4.8125"	n/a
1/3 Page Vertical	2.25" X 9.875"	n/a
1/3 Page Square	4.5625" X 4.8125"	n/a
1/6 Page Vertical	2.25" X 4.8125"	n/a

CUSTOM SPECIALS

Videos

Video links to digital edition ads.
Rate: **\$350**

Special Positions

Special or guaranteed position,
15% EXTRA.

Inserts

Rates on request.

UPLOADING ADS

Email Ads to

blainew@pacificyachting.com

Bleed

Full page only 0.125".

Production Costs

Any production work on advertisements will be invoiced at **\$75 PER HOUR** to the advertiser.

File Formats

Press Optimized PDF

Retail Rates & Dimensions

EFFECTIVE JANUARY 2023, GROSS RATES

RETAIL RATES

SIZE	1X	2X	3X	4X
Full Page	\$2,625	\$2,405	\$2,190	\$1,970
1/2 Horizontal	\$1,800	\$1,645	\$1,500	\$1,344

CUSTOM SPECIALS

Videos

Video links to digital edition ads.

Rate: **\$350**

Special Positions

Special or guaranteed position,
15% EXTRA.

Inserts

Rates on request.

UPLOADING ADS

Email Ads to

blainew@pacificyachting.com

Bleed

Full page only 0.125".

Production Costs

Any production work on advertisements will be invoiced at **\$75 PER HOUR** to the advertiser.

File Formats

Press Optimized PDF



Bulletin Board Rates & Dimensions

Display ads in the Bulletin Board section are reasonably priced and have set sizes. They can include colour borders, background colours, photo backgrounds, superimposed text, logos, inserted photos, etc. See below for pricing and sizes.

EFFECTIVE JANUARY 2023, GROSS RATES

PRODUCTION INFO

Bleed

Full page only 0.125".

Production Costs

Production costs of \$75/hour apply to ads that production must create or change. The average cost of Bulletin Board ad production is **\$25 to \$35**.

File Formats

Press Optimized PDF



<p>FULL PAGE</p> <p>\$1,660</p> <p>A</p> <p>7" x 9 5/8"</p>	<p>3/4 PAGE VERTICAL</p> <p>\$1,245</p> <p>B</p> <p>5 3/16" x 9 5/8"</p>	<p>1/2 PAGE HORIZONTAL</p> <p>\$830</p> <p>C</p> <p>7" x 4 3/4"</p>
<p>1/2 PAGE VERTICAL</p> <p>\$830</p> <p>D</p> <p>3 3/8" x 9 5/8"</p>	<p>3/8 PAGE HORIZONTAL</p> <p>\$625</p> <p>E</p> <p>5 3/16" x 4 3/4"</p>	<p>1/4 PAGE VERTICAL</p> <p>\$455</p> <p>F</p> <p>3 3/8" x 4 3/4"</p>
<p>1 FULL COLUMN</p> <p>\$455</p> <p>G</p> <p>1 9/16" x 9 5/8"</p>	<p>2 COLUMN X3" HORIZONTAL</p> <p>\$365</p> <p>H</p> <p>3 3/8" x 3"</p>	<p>2 COLUMN X2" HORIZONTAL</p> <p>\$275</p> <p>I</p> <p>3 3/8" x 2"</p>

2023 Deadlines & Editorial Calendar

*DATES SUBJECT TO CHANGE

ISSUE	DATES ON SALE	FEATURES	DEADLINES
SPRING	March 20 to June 19*	<ul style="list-style-type: none"> • Spring Roundup: new tourism opportunities for 2023 • Outdoor adventure: spring blooms, hikes, and more • Exploring the Gulf Islands • Local businesses welcome tourists • Destination: TBD (This could be you!) 	Reservation Deadline: 3 FEBRUARY Artwork Deadline: 10 FEBRUARY Newsstand Date: 20 MARCH
SUMMER	June 19 to September 11*	<ul style="list-style-type: none"> • Summer Fun: Road Trips • Guide to BC's best hikes • Climbing in the Rockies • BC's Birds • Destination: TBD (This could be you!) 	Reservation Deadline: 5 MAY Artwork Deadline: 12 MAY Newsstand Date: 19 JUNE
FALL	September 11 to December 11*	<ul style="list-style-type: none"> • Fall adventure: Autumn colours, last hikes of the year • Harvest Time in BC • Guide to fall fishing • Wine Country • Destination: TBD (This could be you!) 	Reservation Deadline: 28 JULY Artwork Deadline: 4 AUGUST Newsstand Date: 11 SEPTEMBER
WINTER	December 11 to March 19, 2024*	<ul style="list-style-type: none"> • Winter Resorts • Ski and snowshoe adventure • Family Fun in the Snow • Christmas reading and gift guide • Destination: TBD (This could be you!) 	Reservation Deadline: 27 OCTOBER Artwork Deadline: 3 NOVEMBER Newsstand Date: 11 DECEMBER

IN EVERY ISSUE

Due West:

Front-end departments featuring quick bites of BC

- Short newsy stories
- Nature / wildlife discoveries
- Culture: upcoming events, exhibitions, festivals
- Travel: Where to go, what to see this season
- Science: breakthroughs and interesting facts
- History: a glimpse into BC's past
- Food and drink: must-try treats
- New products and gear that are relevant to BC Mag readers

Day Trip Diary:

First-person accounts of a single-day adventure or excursion

Echoes:

Looking back on notable events in BC's past

Outdoor Explorer

Tips and tricks on how to make the best out of BC's outdoors

BC Confessions

Funny or reflective stories about life in BC